

P-Channel Enhancement Mode Power MOSFET

Description

The XPX3401AS uses advanced trench technology to provide excellent $R_{DS(ON)}$, low gate charge and operation with gate voltages as low as 2.5V. This device is suitable for use as a load switch or in PWM applications.

- High power and current handing capability
- Lead free product is acquired
- Surface mount package

Application

- PWM applications
- Load switch
- Power management

$$V_{DS} = -30V, I_D = -4.4A$$

$$R_{DS(ON)} = 46m\Omega @ V_{GS} = -4.5V$$

$$R_{DS(ON)} = 39m\Omega @ V_{GS} = -10V$$

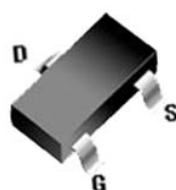

SOT-23-3L

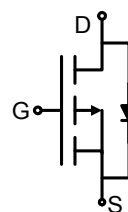

Schematic diagram

Package Marking And Ordering Information

Device Marking	Device	Device Package	Reel Size	Tape width	Quantity
A18E	XPX3401AS	SOT-23-3L	Ø180mm	8 mm	3000 units

Absolute Maximum Ratings ($T_A=25^\circ\text{C}$ unless otherwise noted)

Parameter	Symbol	Limit	Unit
Drain-Source Voltage	V_{DS}	-30	V
Gate-Source Voltage	V_{GS}	± 12	V
Drain Current-Continuous	I_D	-4.4	A
Drain Current-Pulsed ^(Note 1)	I_{DM}	-30	A
Maximum Power Dissipation	P_D	1.3	W
Operating Junction and Storage Temperature Range	T_J, T_{STG}	-55 To 150	$^\circ\text{C}$

Thermal Characteristic

Thermal Resistance, Junction-to-Ambient ^(Note 2)	$R_{\theta JA}$	95	$^\circ\text{C/W}$
---	-----------------	----	--------------------

Electrical Characteristics ($T_A=25^\circ\text{C}$ unless otherwise noted)

Parameter	Symbol	Condition	Min	Typ	Max	Unit
Off Characteristics						
Drain-Source Breakdown Voltage	BV_{DSS}	$V_{GS}=0V, I_D=-250\mu A$	-30	-33	-	V

P-Channel Enhancement Mode Power MOSFET

Parameter	Symbol	Condition	Min	Typ	Max	Unit
Zero Gate Voltage Drain Current	I_{DSS}	$V_{DS}=-24V, V_{GS}=0V$	-	-	-1	μA
Gate-Body Leakage Current	I_{GSS}	$V_{GS}=\pm 12V, V_{DS}=0V$	-	-	± 100	nA
On Characteristics (Note 3)						
Gate Threshold Voltage	$V_{GS(th)}$	$V_{DS}=V_{GS}, I_D=-250\mu A$	-0.7	-1	-1.3	V
Drain-Source On-State Resistance	$R_{DS(on)}$	$V_{GS}=-10V, I_D=-4.2A$	-	39	52	m Ω
		$V_{GS}=-4.5V, I_D=-4A$	-	46	65	m Ω
		$V_{GS}=-2.5V, I_D=-1A$	-	61	80	m Ω
Forward Transconductance	g_{FS}	$V_{DS}=-5V, I_D=-2A$	-	10	-	S
Dynamic Characteristics (Note 4)						
Input Capacitance	C_{iss}	$V_{DS}=-15V, V_{GS}=0V,$ $F=1.0MHz$	-	950	-	PF
Output Capacitance	C_{oss}		-	115	-	PF
Reverse Transfer Capacitance	C_{rss}		-	75	-	PF
Switching Characteristics (Note 4)						
Turn-on Delay Time	$t_{d(on)}$	$V_{DD}=-15V, I_D=-3.2A$ $V_{GS}=-10V, R_{GEN}=6\Omega$	-	7	-	nS
Turn-on Rise Time	t_r		-	3	-	nS
Turn-Off Delay Time	$t_{d(off)}$		-	30	-	nS
Turn-Off Fall Time	t_f		-	12	-	nS
Total Gate Charge	Q_g	$V_{DS}=-15V, I_D=-4A, V_{GS}=-4.5V$	-	9.5	-	nC
Gate-Source Charge	Q_{gs}		-	2	-	nC
Gate-Drain Charge	Q_{gd}		-	3	-	nC
Drain-Source Diode Characteristics						
Diode Forward Voltage (Note 3)	V_{SD}	$V_{GS}=0V, I_S=-1A$	-	-	-1.2	V

Notes:

1. Repetitive Rating: Pulse width limited by maximum junction temperature.
2. Surface Mounted on FR4 Board, $t \leq 10$ sec.
3. Pulse Test: Pulse Width $\leq 300\mu s$, Duty Cycle $\leq 2\%$.
4. Guaranteed by design, not subject to production

Typical Electrical and Thermal Characteristics

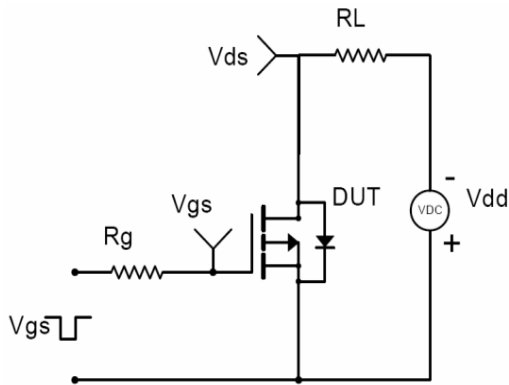

Figure 1: Switching Test Circuit

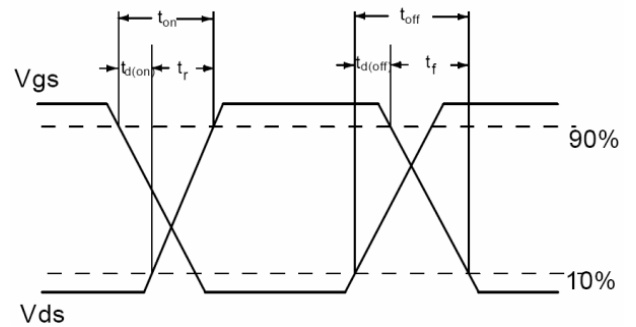

Figure 2: Switching Waveforms

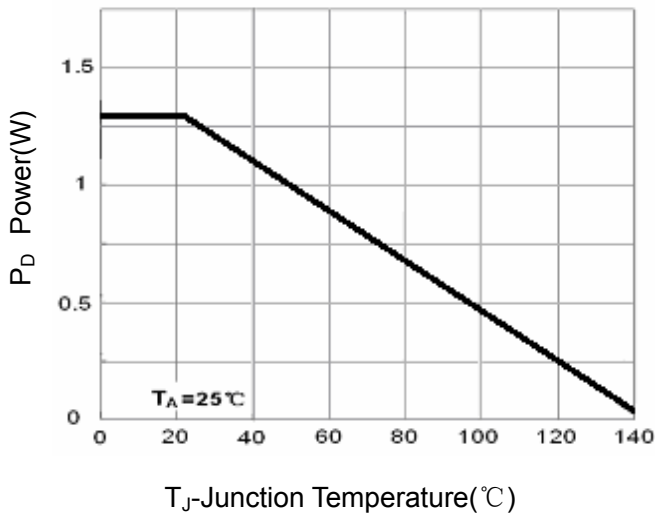

Figure 3 Power Dissipation

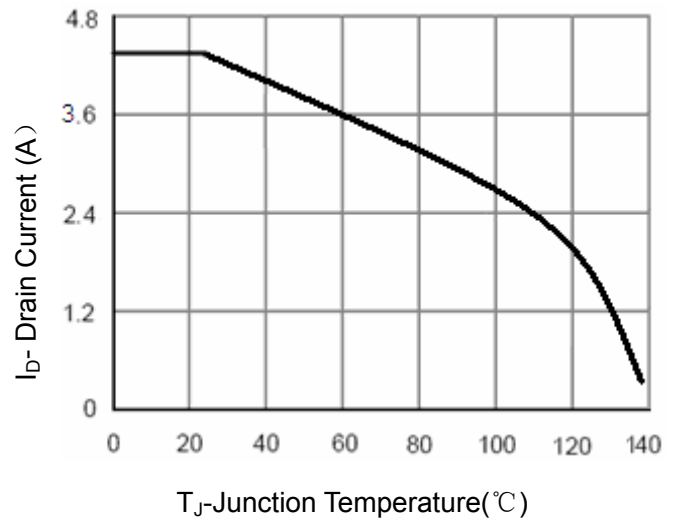

Figure 4 Drain Current

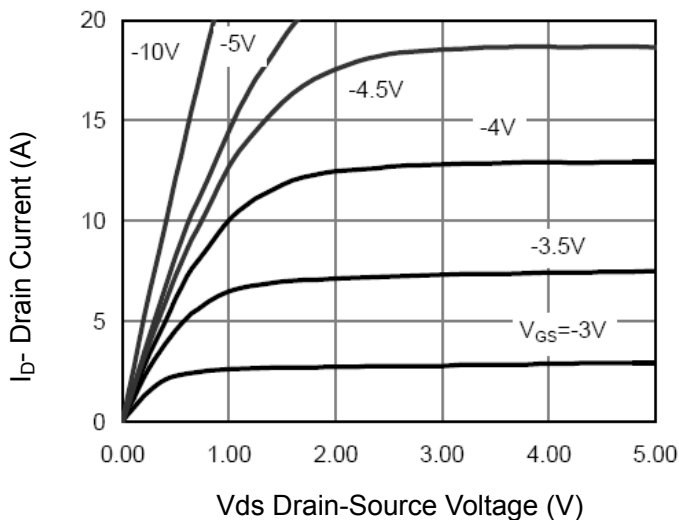

Figure 5 Output Characteristics

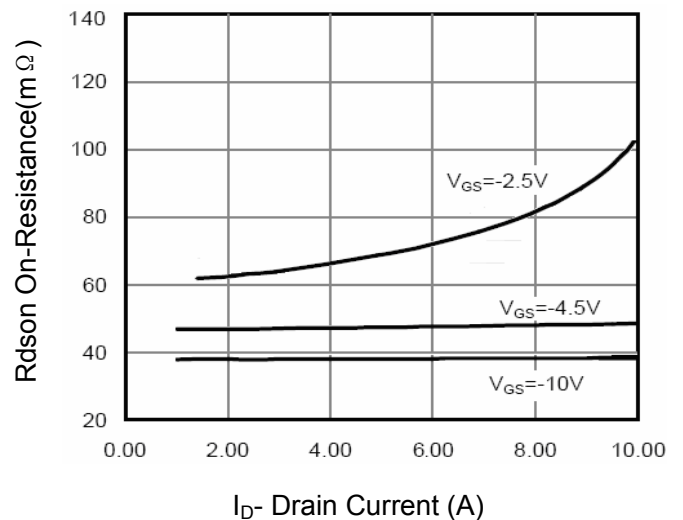

Figure 6 Drain-Source On-Resistance

P-Channel Enhancement Mode Power MOSFET

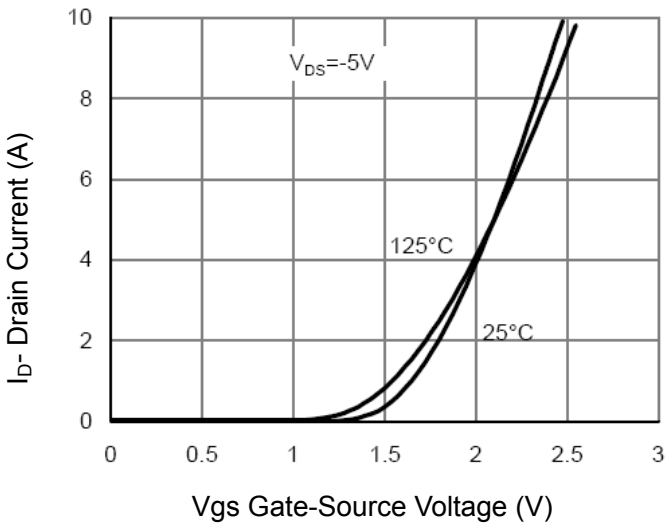

Figure 7 Transfer Characteristics

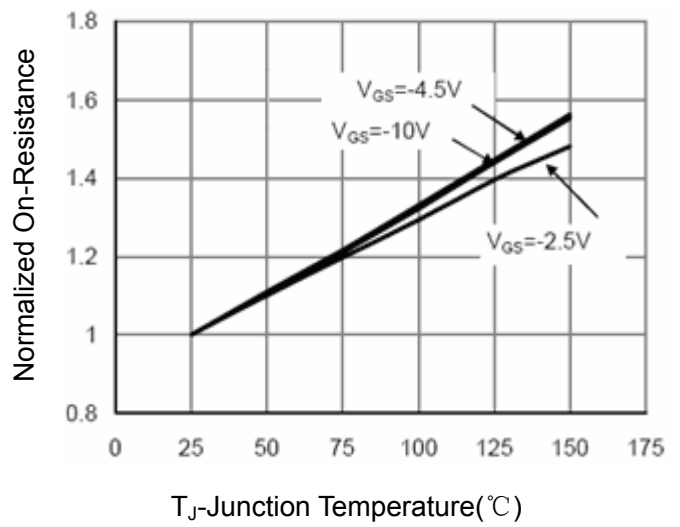

Figure 8 Drain-Source On-Resistance

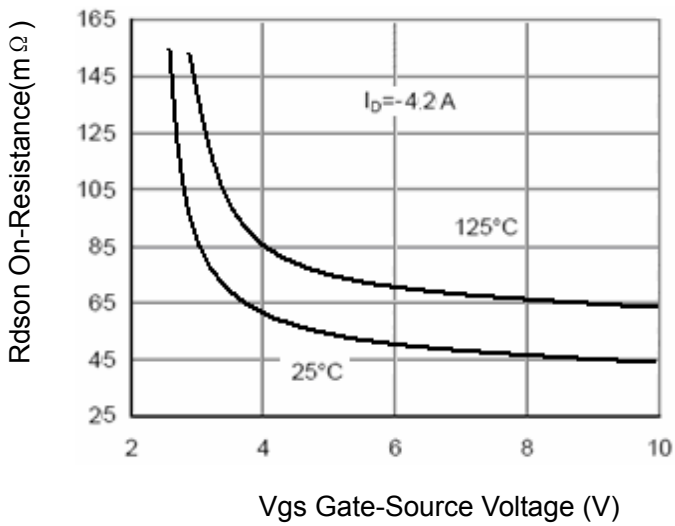

Figure 9 Rdson vs Vgs

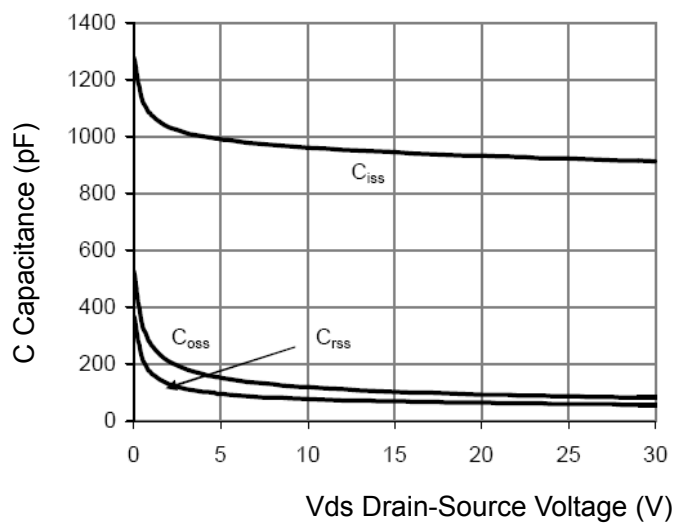

Figure 10 Capacitance vs Vds

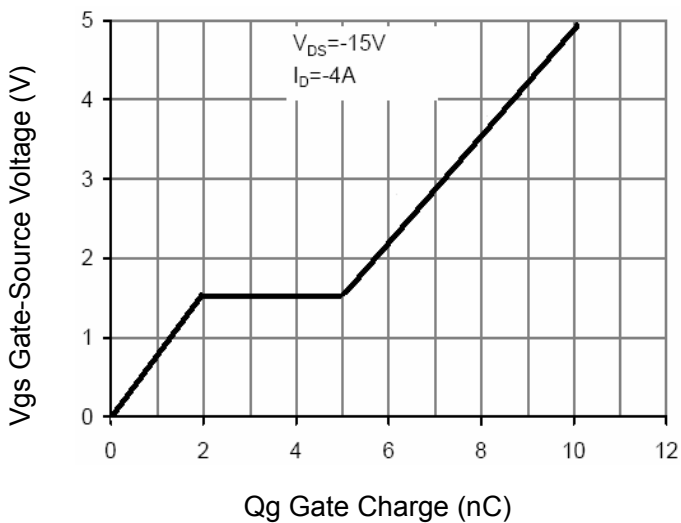

Figure 11 Gate Charge

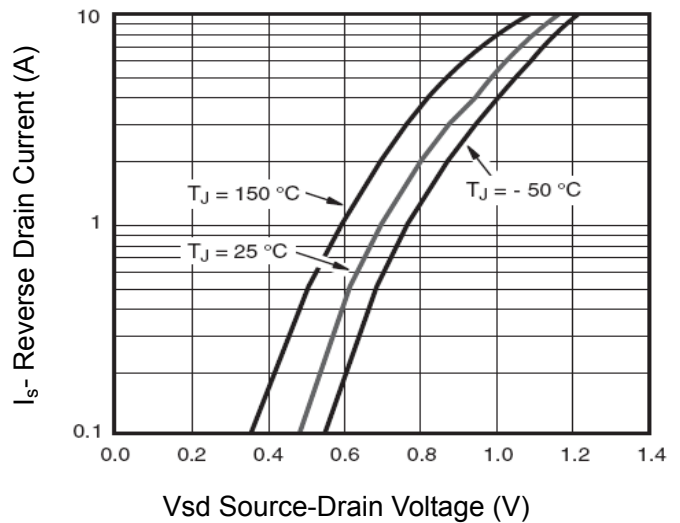

Figure 12 Source-Drain Diode Forward

P-Channel Enhancement Mode Power MOSFET

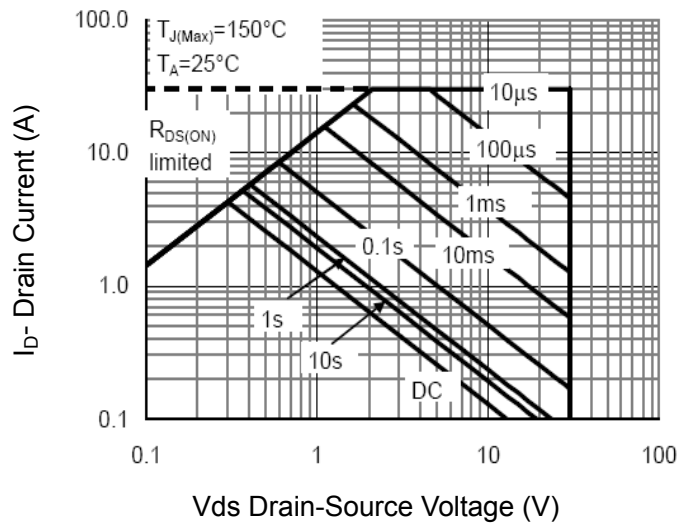

Figure 13 Safe Operation Area

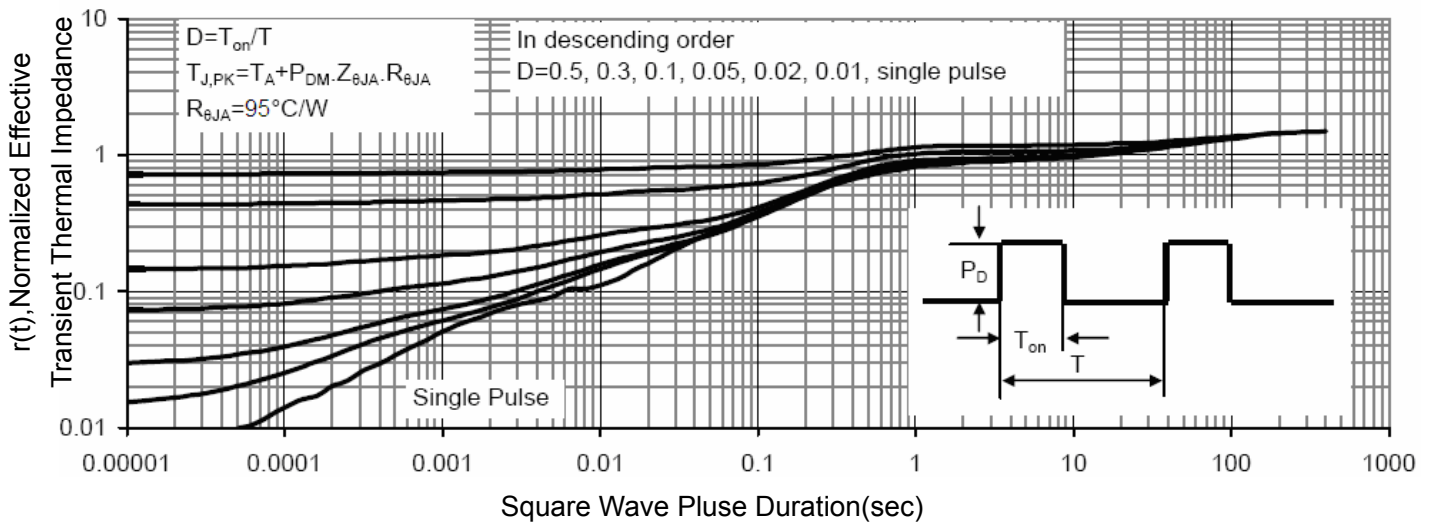
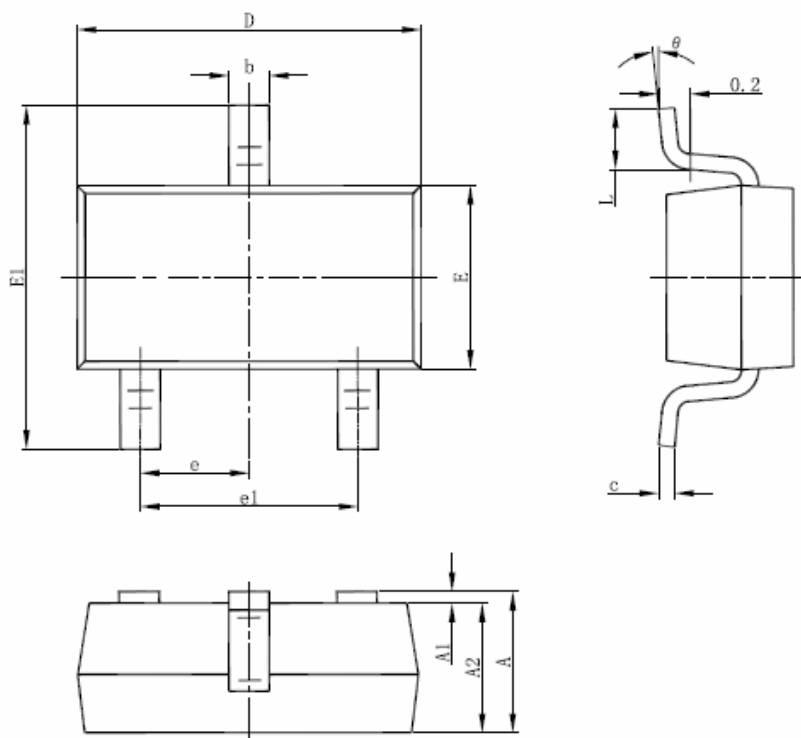

Figure 14 Normalized Maximum Transient Thermal Impedance

SOT-23-3L Package Information

Symbol	Dimensions In Millimeters		Dimensions In Inches	
	Min	Max	Min	Max
A	1.050	1.250	0.041	0.049
A1	0.000	0.100	0.000	0.004
A2	1.050	1.150	0.041	0.045
b	0.300	0.500	0.012	0.020
c	0.100	0.200	0.004	0.008
D	2.820	3.020	0.111	0.119
E	1.500	1.700	0.059	0.067
E1	2.650	2.950	0.104	0.116
e	0.950(BSC)		0.037(BSC)	
e1	1.800	2.000	0.071	0.079
L	0.300	0.600	0.012	0.024
θ	0°	8°	0°	8°

Notes

1. All dimensions are in millimeters.
2. Tolerance $\pm 0.10\text{mm}$ (4 mil) unless otherwise specified
3. Package body sizes exclude mold flash and gate burrs. Mold flash at the non-lead sides should be less than 5 mils.
4. Dimension L is measured in gauge plane.
5. Controlling dimension is millimeter, converted inch dimensions are not necessarily exact.