

### Description

The XPX85N29TV uses advanced trench technology to provide excellent  $R_{DS(ON)}$ , low gate charge and operation with gate voltages as low as 10V.

This device is suitable for use as a Battery protection or in other Switching application.

### General Features

$V_{DS} = 85V$   $I_D = 180A$

$R_{DS(ON)} < 3.5m\Omega$   $V_{GS}=10V$  (Type:  $2.9m\Omega$ )

### Application

Battery protection

Load switch

Uninterruptible power supply

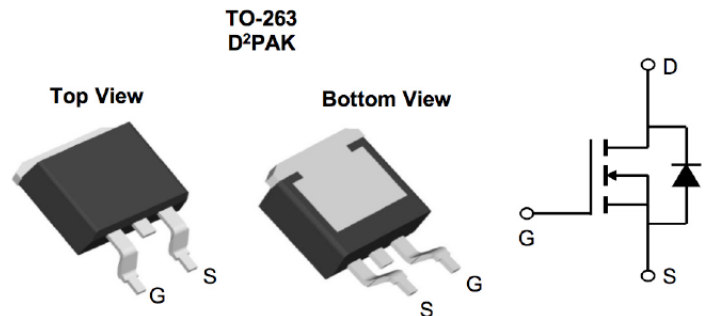

### Package Marking and Ordering Information

Product ID	Pack	Marking	Qty(PCS)
XPX85N29TV	TO-220-3L	XPX85N29TV XXX YYYY	1000
XPX85N29TV	TO-263-3L	XPX85N29TV XXX YYYY	800

### Absolute Maximum Ratings ( $T_C=25^\circ C$ unless otherwise noted)

Symbol	Parameter	Rating	Units
$V_{DS}$	Drain-Source Voltage	85	V
$V_{GS}$	Gate-Source Voltage	$\pm 20$	V
$I_D@T_C=25^\circ C$	Continuous Drain Current, $V_{GS} @ 10V$	180	A
$I_D@T_C=100^\circ C$	Continuous Drain Current, $V_{GS} @ 10V$	100	A
IDM	Pulsed Drain Current	480	A
EAS	Single Pulse Avalanche Energy	858	mJ
$P_D@T_C=25^\circ C$	Total Power Dissipation <sup>4</sup>	284	W
TSTG	Storage Temperature Range	-55 to 150	$^\circ C$
$T_J$	Operating Junction Temperature Range	-55 to 150	$^\circ C$
$R_{\theta JA}$	Thermal Resistance Junction-Ambient	0.53	$^\circ C/W$
$R_{\theta JC}$	Thermal Resistance Junction-Case	48	$^\circ C/W$

### Electrical Characteristics ( $T_J=25^\circ\text{C}$ , unless otherwise noted)

Symbol	Parameter	Conditions	Min	Typ	Max	Unit
V(BR)DSS	Drain-source breakdown voltage	$V_{GS}=0V, I_D=250\mu A$	85	92		V
VGS(th)	Gate threshold voltage	$V_{DS}=V_{GS}, I_D=250\mu A, T_J=25^\circ\text{C}$	2.0	3.0	4.0	V
IDSS	Zero gate voltage drain current	$V_{DS}=80V, V_{GS}=0V, T_J=25^\circ\text{C}$	-		1	$\mu A$
IDSS	Zero gate voltage drain current	$V_{DS}=80V, V_{GS}=0V, T_J=125^\circ\text{C}$		- 5		$\mu A$
IGSS	Gate-source leakage current	$V_{GS}=20V, V_{DS}=0V$	-	-	100	nA
RDS(on)	Drain-source on-state resistance	$V_{GS}=10V, I_D=50A, T_J=25^\circ\text{C}$	-	2.9	3.5	m $\Omega$
gfs	Transconductance	$V_{DS}=5V, I_D=40A$	-	106	-	S
Ciss	Input Capacitance	$V_{GS}=0V, V_{DS}=40V, f=1\text{MHz}$	-	6813	-	pF
Coss	Output Capacitance		-	808	-	pF
Crss	Reverse Transfer Capacitance		-	48	-	pF
Q <sub>G</sub>	Gate Total Charge	$V_{GS}=10V, V_{DS}=40V, I_D=25A$	-	91	-	nC
Q <sub>gs</sub>	Gate-Source charge		-	37	-	nC
Q <sub>gd</sub>	Gate-Drain charge		-	25	-	nC
td(on)	Turn-on delay time	$T_J=25^\circ\text{C}, V_{GS}=10V, V_{DS}=40V, R_L=3\Omega$	-	38	-	ns
t <sub>r</sub>	Rise time		-	58	-	ns
td(off)	Turn-off delay time		-	63	-	ns
t <sub>f</sub>	Fall time		-	32	-	ns
R <sub>G</sub>	Gate resistance	$V_{GS}=0V, V_{DS}=0V, f=1\text{MHz}$	-	2	-	$\Omega$
VSD	Body Diode Forward Voltage	$V_{GS}=0V, I_{SD}=50A$	-	0.85	1.2	V
trr	Body Diode Reverse Recovery Time	$I_F=20A, dI/dt=500A/\mu s$	-	85	-	ns
Qrr	Body Diode Reverse Recovery Charge		-	313	-	nC

#### Note :

- 1、 The data tested by surface mounted on a 1 inch<sup>2</sup> FR-4 board with 2OZ copper.
- 2、 The data tested by pulsed , pulse width .The EAS data shows Max. rating .
- 3、 The test cond  $\cong$  300us duty cycle  $\cong$  2%, duty cycle ition is  $V_{DD}=64V, V_{GS}=10V, L=0.1\text{mH}, I_{AS}=53.8A$
- 4、 The power dissipation is limited by 175 $^\circ\text{C}$  junction temperature
- 5、 The data is theoretically the same as ID and IDM , in real applications , should be limited by total power dissipation.

### Typical Characteristics

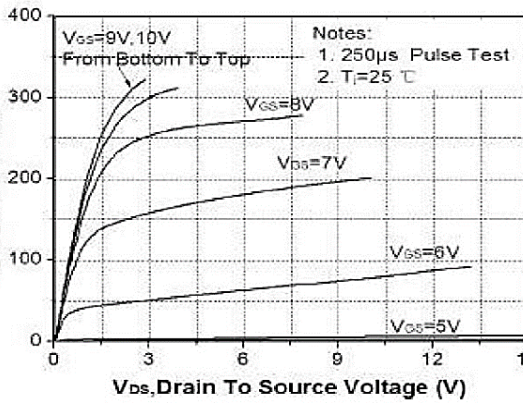

Figure 1. Typ. Output Characteristics (Tj=25 °C)

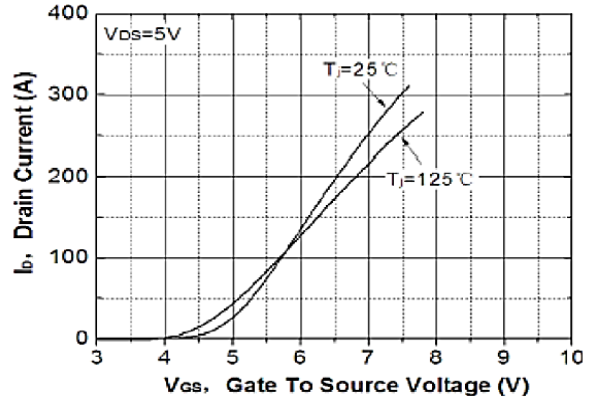

Figure 2. Transfer Characteristics

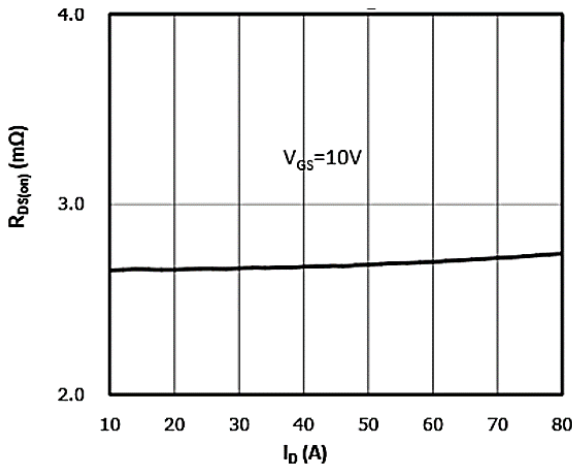

Figure 3. On-Resistance vs. Drain Current and Gate Voltage Figure

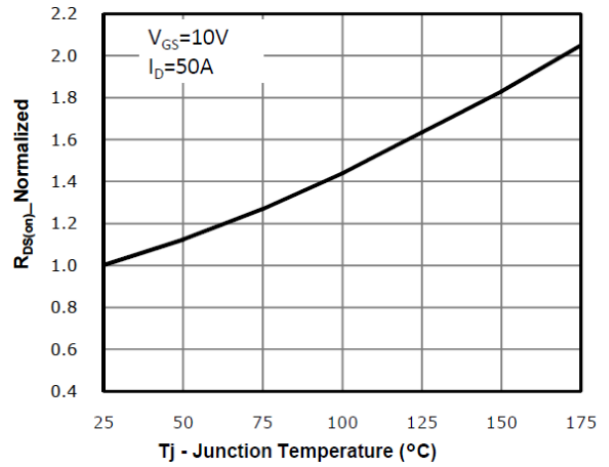

Figure 4. On-Resistance vs. Junction Temperature

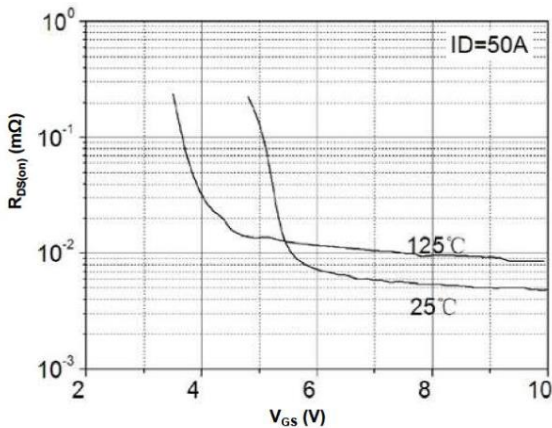

Figure 5. On-Resistance vs. Gate-Source Voltage

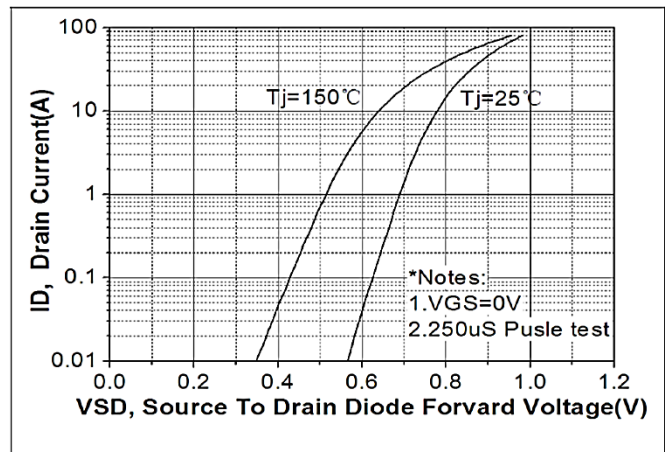

Figure 6. Body-Diode Characteristics

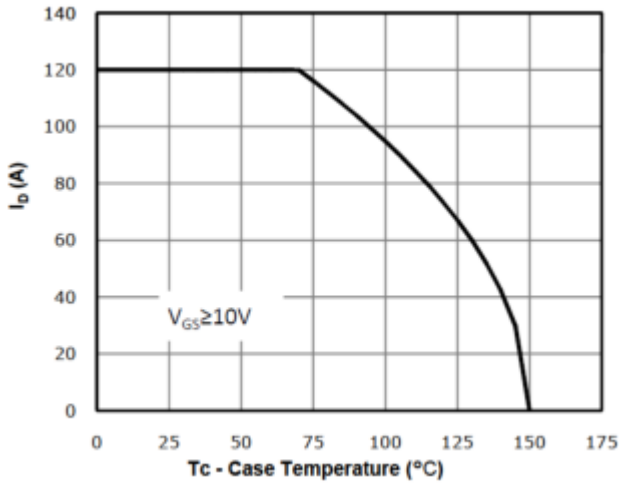

Figure 7. Gate-Charge Characteristics

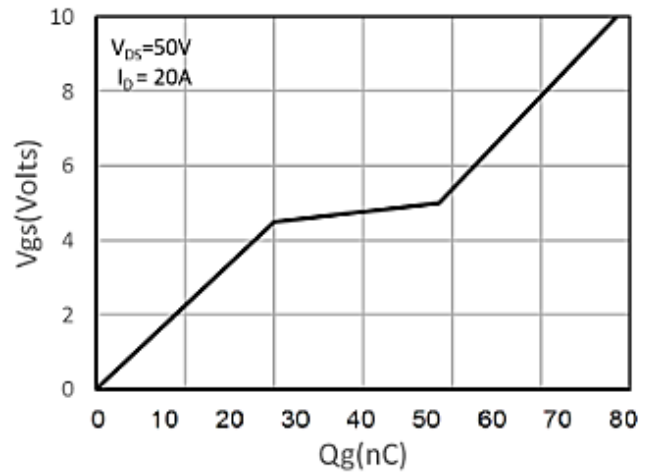

Figure 8. Drain Current Derating

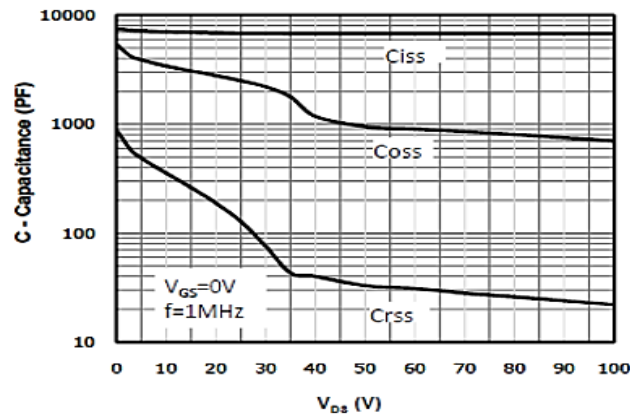

Figure 9: Normalized Maximum Transient Thermal Impedance

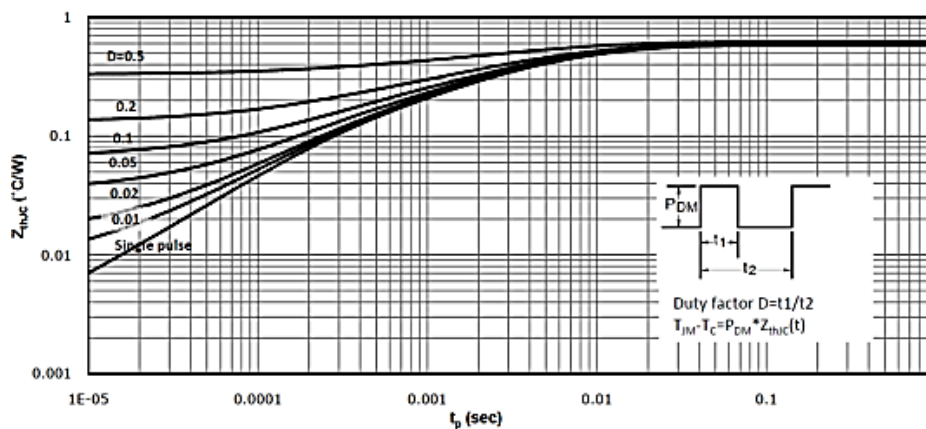
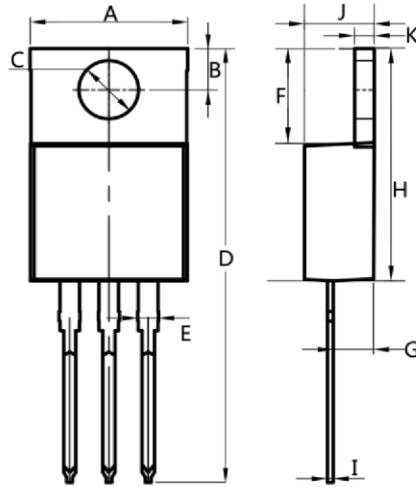

Figure 10. Capacitance Characteristics

TO-220AB



Dim.	Min.	Max.
A	10.0	10.4
B	2.5	3.0
C	3.5	4.0
D	28.0	30.0
E	1.1	1.5
F	6.2	6.6
G	2.9	3.3
H	15.0	16.0
I	0.35	0.45
J	4.3	4.7
K	1.2	1.4

All Dimensions in millimeter

ITO-220AB

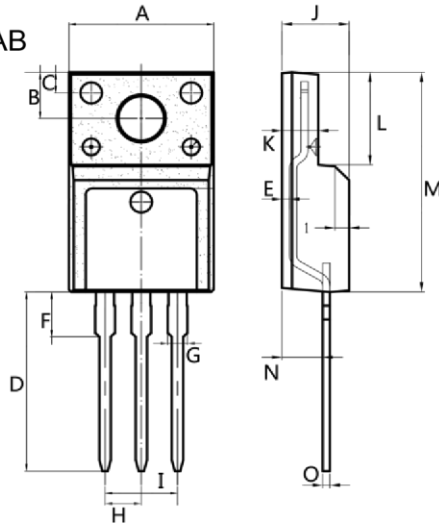

Dim.	Min.	Max.
A	9.9	10.3
B	2.9	3.5
C	1.15	1.45
D	12.75	13.25
E	0.55	0.75
F	3.1	3.5
G	1.25	1.45
H	Typ 2.54	
I	Typ 5.08	
J	4.55	4.75
K	2.4	2.7
L	6.35	6.75
M	15.0	16.0
N	2.75	3.15
O	0.45	0.60

All Dimensions in millimeter

TO-263

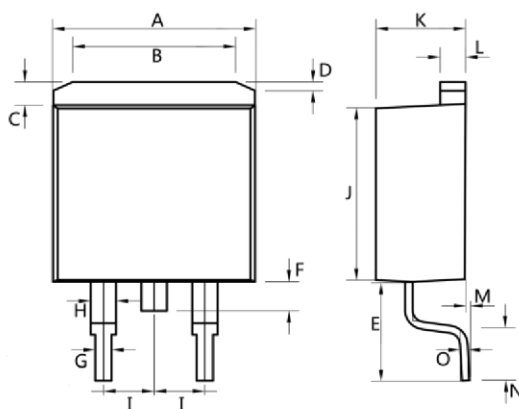

Dim.	Min.	Max.
A	10.0	10.5
B	7.25	7.75
C	1.3	1.5
D	0.55	0.75
E	5.0	6.0
F	1.4	1.6
G	0.75	0.95
H	1.15	1.35
I	Typ 2.54	
J	8.4	8.6
K	4.4	4.6
L	1.25	1.45
M	0.02	0.1
N	2.4	2.8
O	0.35	0.45

All Dimensions in millimeter